

Trolleys Series H

Load capacity up to 120 metric tons



JLB 40 H

JFB 40 H

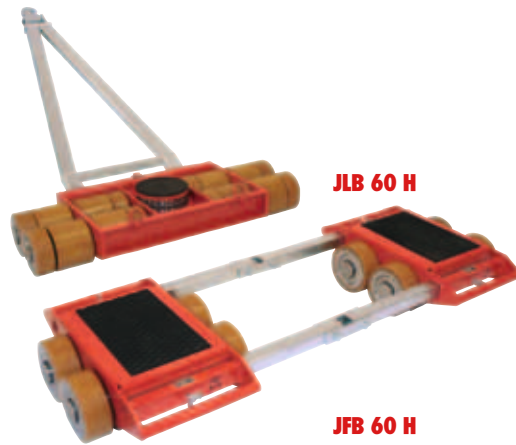

JLB 60 H

JFB 60 H

Available with:

JUWATHan-coated steel castors



for any floors
Order number 95 050 053-V

Available with:

JUWATHan-coated steel castors

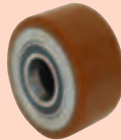

for any floors
Order number 95 050 090-V

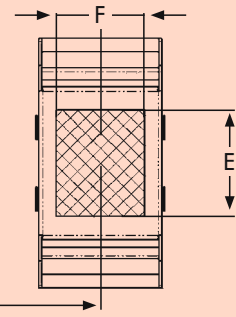
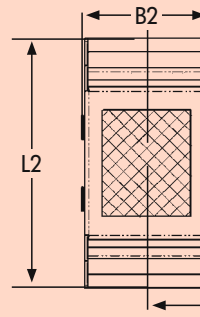
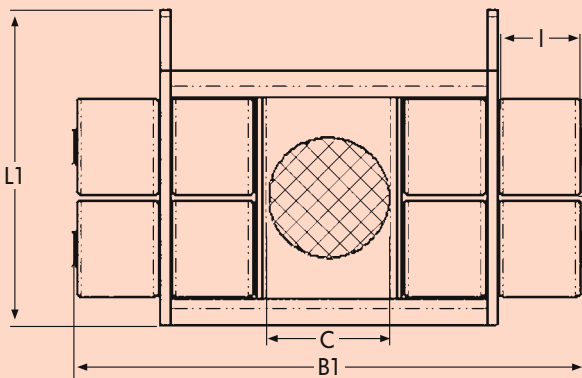

Load weight up to

80 metric tons

120 metric tons

Type	Sketch	JLB 40 H	JFB 40 H	JLB 60 H	JFB 60 H
Load capacity	kg / lbs	40 000 / 88 000	40 000 / 88 000	60 000 / 132 000	60 000 / 132 000
Number of castors	pcs	8	8	8 / 8	8 / 8
Castors dimensions	Ø x l	mm / in	200 x 170 / 7.9 x 6.7"	200 x 170 / 7.9 x 6.7"	200 x 170 / 85 / 79 x 67 / 33" 200 x 170 / 85 / 79 x 67 / 33"
Fitting height	mm / in	230 / 9.1"	230 / 9.1"	230 / 9.1"	230 / 9.1"
Supporting surface per cassette	E x F	mm / in	395 x 260 / 15.6 x 10.2"	395 x 260 / 15.6 x 10.2"	395 x 260 / 15.6 x 10.2"
Cassette dimensions	L2 x B2	mm / in	740 x 395 / 29.1 x 15.6"	740 x 395 / 29.1 x 15.6"	740 x 580 / 29.1 x 22.8"
Connecting rod with joint	Length	mm / in	2 x 1 540 / 60.6"	2 x 1 540 / 60.6"	2 x 1 540 / 60.6"
Cassettes adjustable from - to	G - H	mm / in	585 - 1 155 / 23 - 45.5"	585 - 1 155 / 23 - 45.5"	700 - 2 800 / 27.6 - 110.2"
Supporting surface of turnable	Ø C	mm / in	250 / 9.8"	250 / 9.8"	250 / 9.8"
Dimensions	L1 x B1	mm / in	650 x 1 060 / 25.6 x 41.7"	650 x 1 060 / 25.6 x 41.7"	650 x 1 400 / 25.6 x 55.1"
Handlebar with pulling eye	Length	mm / in	1 590 / 62.6"	1 590 / 62.6"	1 590 / 62.6"
Weight JUWATHan plus	kg / lbs	320 / 705	289 / 637	450 / 992	410 / 904
Order-no. with JUWATHan		09 400 200-H	10 400 200-H	09 600 200-H	10 600 200-H

Trolleys Series H

Load capacity up to 160 metric tons



JL 80 H

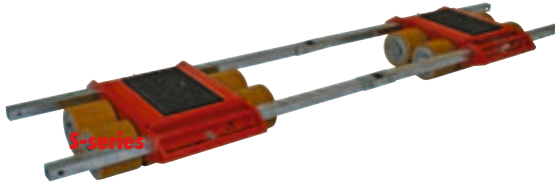

JFB 80 H

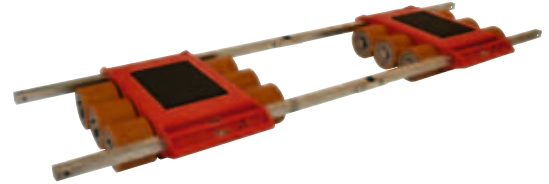

JFB 120 H

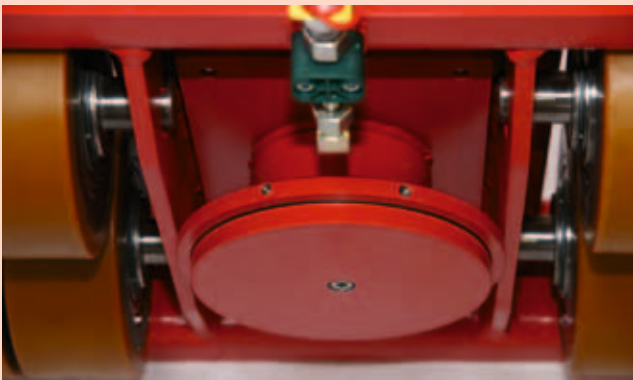

Turning assistance for H series trolleys available on request

Advantages in detail

- Outfitted with highest quality rollers as standard.
- Unrivalled: Small and lightweight trolleys at super high capacity.
- Reduced weight through advanced construction of frames.
- All transport trolleys are ready for use: The steerable transport trolley is fitted with a ball bearing supported turntable and a handlebar (as shown in picture). The adjustable-width transport trolley consists of two transport units and connecting rods.

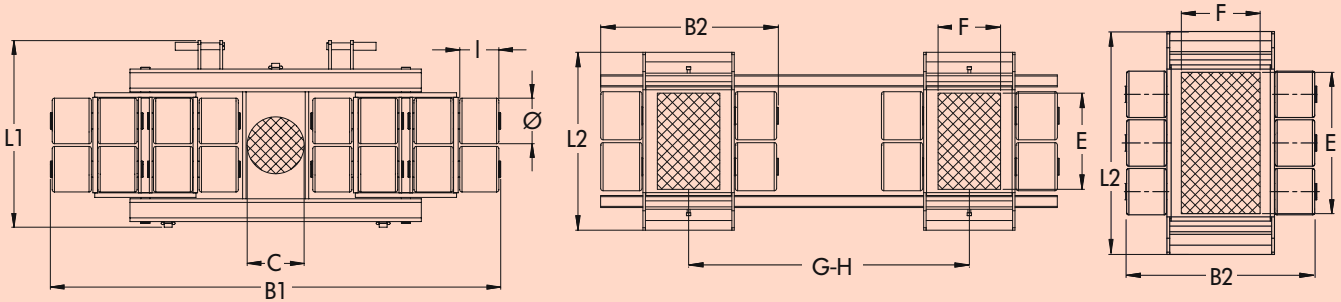

Type	Sketch		JL 80 H	JFB 80 H	JFB 120 H
Load capacity		kg / lbs	80 000 / 176 000	80 000 / 176 000	120 000 / 265 000
Number of castors		pcs	16	16	24
Castors dimensions	Ø x l	mm / in	200 x 170 / 7.9 x 6.7"	200 x 170 / 7.9 x 6.7"	200 x 170 / 7.9 x 6.7"
Fitting height		mm / in	240 / 9.4"	240 / 9.4"	240 / 9.4"
Supporting surface per cassette	E x F	mm / in		400 x 260 / 15.7 x 10.2"	440 x 300 / 17.3 x 11.8"
Cassette dimensions	L2 x B2	mm / in		750 x 820 / 29.5 x 32.2"	960 x 830 / 37.7 x 32.6"
Connecting rod with joint	Length	mm / in		2 x 3 000 / 118"	2 x 3 000 / 118"
Cassettes adjustable from - to	G - H	mm / in		1 630 - 3 380 / 64.1-132.9"	1 630 - 3 380 / 64.1-132.9"
Supporting surface of turntable	Ø C	mm / in	250 / 9.8"		
Dimensions	L1 x B1	mm / in	820 x 1 900 / 32.2 x 74.7"		
Handlebar with pulling eye	Length	mm / in	1 590 / 62.6"		
Weight JUWAtan plus		kg / lbs	723 / 1 594	565 / 1 246	815 / 1 797
Order-no. with JUWAtan			09 800 200-H	10 800 200-H	10 912 200-H